



Authorised User No. 00007



INSTALLATION & MAINTENANCE MANUAL

LogiCool

Free-Cooling Chiller
20 kW - 40 kW

R410A



ISO 14001
EM552086



ISO 9001
FM00542

About Airedale Products & Customer Services

WARRANTY, COMMISSIONING & MAINTENANCE

The equipment carries the Airedale **unit parts and labour warranty** in respect of non-consumable parts, for a period of **12 months** from the date of commissioning or **18 months** from the date of despatch. (Excludes the cost of any specialist access or lifting equipment.) Commissioning will be carried out by Airedale International Air Conditioning Ltd or an approved Airedale commissioning company.

To further protect your investment in Airedale products, we have introduced Airedale Service, who can provide full commissioning services, comprehensive maintenance packages and service cover 24 hours a day, 365 days a year (UK mainland). For a free quotation contact Airedale Service or your local Sales Engineer.

All Airedale products are designed in accordance with EU Directives regarding prevention of build up of water, associated with the risk of contaminants such as Legionella.

Where applicable, effective removal of condensate is achieved by gradient drainage to outlets and where used, humidification systems produce sterile, non-toxic steam during normal operation.

For effective prevention of such risk it is necessary that the equipment is maintained in accordance with Airedale recommendations.

CAUTION

Warranty cover is not a substitute for Maintenance. Warranty cover is conditional to maintenance being carried out in accordance with the recommendations provided during the warranty period. Failure to have the maintenance procedures carried out will invalidate the warranty and any liabilities by Airedale International Air Conditioning Ltd.

SPARES

A spares list for 1, 3 and 5 years will be supplied with every unit and is also available from our Spares department on request.

TRAINING

As well as our comprehensive range of products, Airedale offers a modular range of Refrigeration and Air Conditioning Training courses, for further information please contact Airedale.

CUSTOMER SERVICES

For further assistance, please e-mail: enquiries@airedale.com or telephone:

UK Sales Enquiries	+ 44 (0) 113 238 7789	enquiries@airedale.com
International Enquiries	+ 44 (0) 113 239 1000	enquiries@airedale.com
Spares Hot Line	+ 44 (0) 113 238 7878	spares@airedale.com
Airedale Service	+ 44 (0) 113 239 1000	service@airedale.com
Technical Support	+ 44 (0) 113 239 1000	tech.support@airedale.com
Training Enquiries	+ 44 (0) 113 239 1000	marketing@airedale.com

For information, visit us at our Web Site: www.airedale.com

AIAC Ltd endeavours to ensure that the information in this document is correct and fairly stated, but none of the statements are to be relied upon as a statement or representation of fact. AIAC Ltd does not accept liability for any error or omission, or for any reliance placed on the information contained in this document.

The development of Airedale products and services is continuous and the information in this document may not be up to date. It is important to check the current position with AIAC Ltd at the address stated. This document is not part of a contract or licence unless expressly agreed.

No part of this document may be reproduced or transmitted in any form or by any means, electronic or mechanical, including photocopying, recording, or information storage and retrieval systems, for any purpose other than the purchaser's personal use, without the express written permission of AIAC Ltd.

© 2013 Airedale International Air Conditioning Limited. All rights reserved. Printed in the UK.

Contents

General Statement	4
Safety	4
Warranty	5
General Description	6
Unit Identification	6
Introduction	6
Refrigerant	6
Construction	7
Standard Features - Energy Saving	7
Compressors	7
Standard Features - General	10
Optional Extras - General	11
Installation Data	12
Dimensions	12
Weights	12
Unit Lifting	13
Positioning	14
Water System	15
Glycol Data	16
Standard Recommended Installation	17
System Schematic	18
Electrical	19
Interconnecting Wiring	19
Electrical Data	20
Controls	21
Temperature Control	21
Operation	22
Setting up	23
Viewing Unit Operating Status	24
Alarms	25
Commissioning Data	27
Operating Limits	27
Mechanical Data	27
Waterside Pressure Drops	28
Pump Packages (Optional Extras)	29
Operational Sequence	31
Commissioning Procedure	32
Pre Commissioning Checklist	32
Commissioning Checklist	34
Maintenance	35
General Maintenance	35
Compressor Maintenance	36
Shut Down Periods	36
Parts Identification	38
Spares	38

General Statement

IMPORTANT

The information contained in this manual is critical to the correct operation and maintenance of the unit and should be read by all persons responsible for the installation, commissioning and maintenance of this Airedale unit.

SAFETY

The equipment has been designed and manufactured to meet international safety standards but, like any mechanical/electrical equipment, care must be taken if you are to obtain the best results.

- CAUTION** ▼ 1 **Installation, service and maintenance of Airedale equipment should only be carried out by technically trained competent personnel.**
- CAUTION** ▼ 2 **When working with any air conditioning units ensure that the electrical isolator is switched off prior to servicing or repair work and that there is no power to any part of the equipment.**
- 3 Also ensure that there are no other power feeds to the unit such as fire alarm circuits, BMS circuits etc
- 4 Electrical installation commissioning and maintenance work on this equipment should be undertaken by competent and trained personnel in accordance with local relevant standards and codes of practice.
- 5 Refrigerant used in this range of products is classified under the COSHH regulations as an irritant, with set Occupational Exposure Levels (OEL) for consideration if this plant is installed in confined or poorly ventilated areas.
- 6 A full hazard data sheet in accordance with COSHH regulations is available should this be required.

SPARES

For ease of identification when ordering spares or contacting Airedale about your unit, please quote the unit type, unit serial number and the date of manufacture, which can be found on the unit serial plate.

A spares list for 1, 3 and 5 years will be supplied with every unit and is also available from our Spares department on request.

SERIAL PLATE

The serial plate can be located to the inside of the control panel door, refer to **Parts Identification** section.

AIREDALE		UK Office	☎ + 44 113 2391000	☎ + 44 113 2507219
Unit/Gerät/Unite	LCC40			
Serial/Serie/Serie	81543668-001 (63091072)			
Manufactured/Hergestellt/Fabriqué	24/01/2007			
Supply/Spannung/Alimentation	400 V 3 PH 50 Hz			
Fuse/Hauptsicherung/Fusibles	25.0 A			
Test Pressure Prüfdruck Pression d'essai	58.0 BAR			
Refrigerant & Charge Kältemittel und Füllung Refrigerant & Charge				
Max. operating pressure Betriebsdruck (Maximal) Pression de marche (Maximum) N.B. No: 0086				
www.airedale.com		CE		

Warranty

GENERAL

To be read in conjunction with Airedale International Air Conditioning Ltd standard Conditions of Sale and any related quotation.

The equipment carries Airedale's standard **Parts** (non consumable) & **Labour** warranty for a period of **12 months** from the date of commissioning or **18 months** from the date of despatch, whichever is the sooner. Commissioning must be carried out by Airedale or an approved Airedale company.

WARRANTY IS ONLY VALID IN THE EVENT THAT:

- 1 In the period between delivery and commissioning the equipment:
 - is properly protected & serviced
 - water flow safety devices are in place and fully operational
- 2 The equipment is serviced & maintained by Airedale or an approved Airedale company in accordance with the Installation & Maintenance manual provided, during the Warranty Period.

In the event of a problem being reported, Airedale will cover the full cost of rectification (excluding costs for any specialist access or lifting equipment) if warranty is valid under these conditions.

Any spare part supplied by Airedale under the warranty shall be warranted for the unexpired period of the warranty or 3 months from delivery whichever period is the longer, with the exception of compressors on which a further 12 months warranty is granted.

PROCEDURE

- The on site contractor or service company place an official order on Airedale for the replacement part including site labour if required. Airedale will acknowledge this order with detailed prices for components, travel and labour rates.
- Should warranty be accepted, following inspection of the faulty component, a credit note will be issued against the invoice raised in line with the acknowledgement.
- Should warranty be refused the invoice raised against the acknowledgement becomes payable on normal terms.
- Airedale reserves the right to carry out site warranty labour work using their own direct labour or by sub contracting to an approved company of their choice.

EXCLUSIONS

Warranty may be refused for the following reasons:

- Misapplication of product or component
- Incorrect site installation
- Incomplete commissioning documentation
- Inadequate site installation
- Inadequate site maintenance
- Damage caused by mishandling
- Replaced part being returned damaged without explanation
- Unnecessary delays incurred in return of defective component

GENERAL

Dead on arrival or manufacturing defects are the responsibility of Airedale and should be reported immediately.

In the event of a warranty failure, dead on arrival or manufacturing defect, the Airedale Service department should be contacted and on receipt of an order, an Airedale engineer (or representative) will be directed to site as soon as possible.

RETURNS ANALYSIS

All faulty components returned under warranty are analysed on a monthly basis as a means of verifying component and product reliability as well as supplier performance. It is important that all component failures are reported correctly.

General Description

UNIT IDENTIFICATION

LCC	LogiCool Free-Cooling Chiller	LCC	20
20 - 40	Model Size (Expressed as Nominal Cooling in kW)		

INTRODUCTION

The Airedale range of LogiCool Compact air cooled liquid chillers covers the nominal capacity range 20kW to 40kW in 2 model sizes.

This range has been developed for high heat load requirements and is ideally suited to Server room applications. Offering simultaneous DX Mechanical cooling and Free-Cooling operation, the range utilises the latest technology to achieve a high level of energy efficient operation.

As standard, the LogiCool offers modulating capacity control through the use of digital scroll compressor technology and further increased energy efficiency with optional EC Fans, refer to **Optional Extras - Energy Saving** for details.

Attention has been placed on maximising the unit's cooling and energy performance while keeping the footprint to an absolute minimum.

CE DIRECTIVE



Airedale certify that the equipment detailed in this manual conforms with the following EC Directives:

Electromagnetic Compatibility Directive (EMC)	89/336/EEC
Low Voltage Directive (LVD)	73/23/EEC
Machinery Directive (MD)	89/392/EEC in the version 98/37/EC
Pressure Equipment Directive (PED)	97/23/EC

To comply with these directives appropriate national & harmonised standards have been applied. These are listed on the Declaration of Conformity, supplied with each product.

REFRIGERANT

The range has been designed and optimised for operation with ozone benign refrigerant **R410A**.

General Description

CONSTRUCTION

The base is fabricated from galvanised steel coated with epoxy baked powder paint to ensure a durable, weatherproof construction.

Unit panels are manufactured from galvanised sheet steel coated with epoxy baked powder paint to provide a durable and weatherproof finish.

Standard unit colour is Light Grey (RAL 7035).

Fully weatherproofed electrical panels are situated at one end of the unit.

Access to the water and refrigeration components is via the lower front panel.

Coil guards are fitted as standard.

A set of 4 collared eye bolts to BS4278 are supplied.

STANDARD FEATURES - ENERGY SAVING

COMPRESSORS

Scroll compressor(s) comprising:

- Internal motor protection
- Internal pressure relief
- External discharge temperature protection
- Oil sight glass

LCC20

Utilises 1 digital scroll compressor offering modulating capacity control between 20 - 100% of unit capacity.

LCC40

Utilises 1 digital scroll compressor coupled in tandem with 1 standard scroll compressor offering modulating capacity control between 10 - 100% of unit capacity.

Digital Scroll Compressors

Digital scroll compressor technology offers compressor capacity modulation from 20% to 100% achieved by the use of an externally integrated long life electronically controlled solenoid valve which loads and unloads the compressor scroll based on a 20 second cycle.

The solenoid valve uses suction and discharge pressures through a modulation chamber to cause a spring loaded piston attached to the top scroll to fall down at high pressure and move up at low. The moving of the piston separates the scrolls and results in no compression of refrigerant.

As the digital compressor is always operating at either 100% or 0% the mass flow of refrigerant through the system is always high, simplifying component selection and pipe work design to guarantee oil return.

Energy Efficiency

The digitally modulated solenoid achieves capacity modulation of 20% to 100% by varying the loaded or unloaded compressor cycle time and averaging the sum of the loaded and unloaded state. The digital scroll compressor operates in an unloaded state for a proportion of the 20 second cycle time; as a result, the load on the compressor is greatly reduced as refrigerant is not drawn. Consequently the energy consumed at partial load condition is only a percentage of that consumed during full load condition, ie:

$$\frac{(\text{Loaded Time} \times 100\%) + (\text{Unloaded Time} \times 10\%)}{(\text{Loaded Time} + \text{Unloaded Time})} = \text{Average Power}$$

General Description

STANDARD FEATURES - ENERGY SAVING

Digital Scroll Compressors

Operation

The following examples illustrate the flexibility of the digital compressor loading stages within the 20 second cycle time:

Example A

Where: Solenoid Energised = 10 seconds Loaded Time
 Solenoid De-energised = 10 seconds Unloaded Time

$$\frac{(10 \times 100\%) + (10 \times 0\%)}{20} = 50\%$$

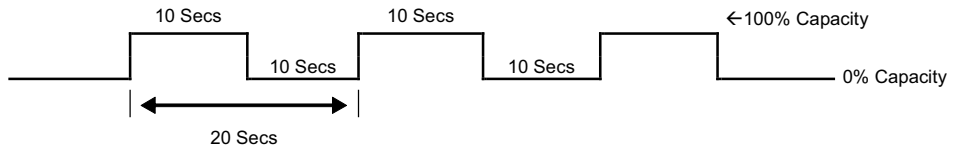

Example B

Where: Solenoid Energised = 5 seconds Loaded Time
 Solenoid De-energised = 15 seconds Unloaded Time

$$\frac{(15 \times 100\%) + (5 \times 0\%)}{20} = 75\%$$

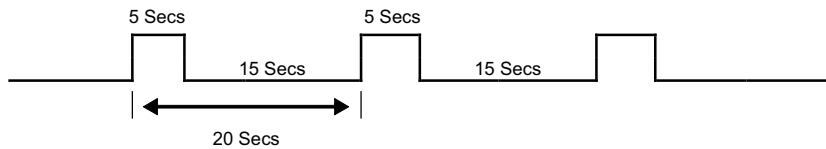

Control & Monitoring

The systems superheat is controlled by a dedicated microprocessor and digital compressor performance is monitored via the AireTronix controller display.

CAUTION



The digital scroll compressor is always operating at either 100% or 0% mass flow. When inspecting the refrigerant system with gauges, this is evident by pulsing of the system pressures. Therefore, all pressure measurements MUST be taken when the digital scroll compressor is compressing refrigerant (solenoid de-energised).

General Description

STANDARD FEATURES - ENERGY SAVING

Electronic Expansion Valves (EEV)

Electronic expansion valves differ to the normal thermostatic expansion valves in their ability to maintain control of the suction superheat at reduced head pressures. This can lead to significant energy savings particularly at reduced loading and low ambient temperatures. Factory fitted, for full details refer to the *Technical Manual*.

Evaporator

Stainless steel high efficiency brazed plate heat exchanger(s) will allow optimum heat transfer between media. Each heat exchanger is insulated with closed cell polyurethane foam to Class 1 fire rating and the material is UV resistant.

A self-regulating pad heater is fitted to the single evaporator and will protect against freeze up in ambient temperatures as low as -20°C.

Condenser

Large surface area coil(s) ideally positioned to optimise airflow and heat transfer, manufactured from refrigeration quality copper tubes with mechanically bonded aluminium fins.

The copper tube is internally rifled for improved heat transfer.

Free-Cooling Coil

Large surface area coil(s) ideally positioned to optimise airflow and heat transfer, manufactured from copper tubes with mechanically bonded aluminium fins.

Spacing between condenser and free-cooling coils is provided for cleaning maintenance along with top access holes and drain holes to the base.

Fan & Motor Assembly

Sickle bladed fan assemblies with integral long bellmouth and fingerproof grille, incorporate external rotor ac motor technology, capable of highly accurate discreet speed control, discharges air vertically. The fans offer maximum airflow performance while keeping sound levels to a minimum.

Each fan is speed controllable and operates from a 3 phase electrical supply.

Energy efficient Electronically Commutated (EC) fans are also available, refer to *Optional Extras - Energy Saving*.

Head Pressure Control

3 phase head pressure controllers are fitted which modulate the fan speed to maintain a constant condensing pressure in the DX mechanical cooling mode and afford reductions in input power when overcooling in low ambients.

A pressure transducer is fitted to the liquid line which in turn feeds back the head pressure to the microprocessor. The condenser fan speed can then modulate via the controller to provide optimum control under varying ambient conditions. The head pressure can be monitored via the display keypad.

Additional refrigeration valves are fitted to allow mechanical and free-cooling functions to operate simultaneously in order to maximise free-cooling and minimise energy consumption.

General Description

STANDARD FEATURES - GENERAL

Refrigeration

Each refrigeration circuit is supplied with the following:

- Full operating charge of R410A
- Electronic Expansion Valve (EEV)
- Liquid line ball valve
- Discharge line ball valve
- Liquid line filter drier
- Liquid line sight glass
- Low pressure switch with manual reset via microprocessor controller
- High pressure switch with manual reset
- Suction and liquid pressure transducers
- Valves for refrigeration head pressure control

Water / Glycol

Each water glycol circuit is supplied with the following:

- 3 way modulating valve to control free-cooling operation
- Strategically placed automatic air vents
- Strategically placed drain valves
- Ball valve(s) for Free-cooling coil isolation to allow for maintenance
- Pressure transducer(s) across evaporator to monitor water pressure drop
- Inlet water filter ball valve 20 mesh

Flushing Bypass Kit (Standard)

Comprises:

- Shut off valves

Factory fitted to protect the evaporator from clogging by sediment and to enable the system to be purged before running.

Controls

As standard, the **AIRE**Tronix microprocessor controller can provide modulating capacity control.

Optionally, the controller is designed to provide capabilities for;

- Building Management Systems

to meet all your system requirements, please confirm at time of order.

For further details, refer to **Controls**.

Evaporator Differential Pressure Sensor

Facilitates low flow limiting and pressure drop monitoring via the microprocessor.

Measures the evaporator pressure drop which in turn enables the evaporator flow rate to be calculated.

General Description

STANDARD FEATURES - GENERAL

Electrical Dedicated weatherproof electrical power and controls panels are situated at the front of the unit and contain:

- Separate, fully accessible, controls compartment
- Circuit breakers for protection of all major unit components
- Separate, permanent supply for controls/trace heating, 230V / 50Hz / 1Ph

CAUTION  **A fused and isolated electrical supply of the appropriate phase, frequency and voltage should be installed.**

The electrical power and control panel is wired to the latest European standards and codes of practice.

Mains supply is 3 phase and a neutral is not required. Refer to *Interconnecting Wiring*.

Electrical terminals for external evaporator pipework trace heating (240V/500W) are provided.

OPTIONAL EXTRAS - ENERGY SAVING

Electronic Soft Start The electronic soft start enables the chiller compressor motor to be ramped to speed with the minimum full load current. Further benefits include removal of nuisance tripping, supply voltage dips and motor overheating.

Electronically Commutated (EC) Fan Motor Sickle bladed fan assemblies with integral long bellmouth and fingerproof grille. Incorporate external EC rotor motor technology, to provide highly accurate discreet speed control, discharge air vertically. The fans offer maximum airflow performance while keeping sound levels to a minimum.

Each fan incorporates on board electronics with inverter-driven DC motor control, responding to a signal from the unit microprocessor.

For further details, please refer to *Technical Manual*.

OPTIONAL EXTRAS - GENERAL

Loose Item

- Anti Vibration Mounts - Instructions supplied with item

Factory Fitted

- Corrosion Resistant Coated Coils
- BMS Interface Card
- Leak Detection System
- Remote Setpoint Adjust
- Flushing Bypass Kit (Incl. Shut off & Water Regulating Valve)
- Integral Pump Packages
- Compressor Oil Heater
- Expansion Vessel
- Alternative Refrigerant (Outside EU)

OPTIONAL UNIT COVER

- Commissioning
- Chillerguard® Maintenance (1) } For details and a competitive quotation, contact Airedale Service.

(1) UK Mainland Sites

Installation Data

UNIT LIFTING

- Employ lifting specialists
- Local codes and regulations relating to the lifting of this type of equipment should be observed
- Use the lifting eye bolts/lifting lugs provided
- Attach lifting chains to the 4 lifting eye bolts/lifting lugs provided; each chain and eye bolt must be capable of lifting the whole chiller
- Use the appropriate spreader bars/lifting slings with the holes/lugs provided
- Chains/slings **MUST NOT** interfere with the casing of fan assembly to avoid damage
- Lift the unit slowly and evenly

IMPORTANT  **If the unit is dropped, it should immediately be checked for damage and reported to Airedale.**

CAUTION  **Only use lifting points provided.**

The unit should be lifted from the top and where possible, with all packing and protection in position. If any other type of slinging is used, due care should be taken to ensure that the slings do not crush the casework or coil.

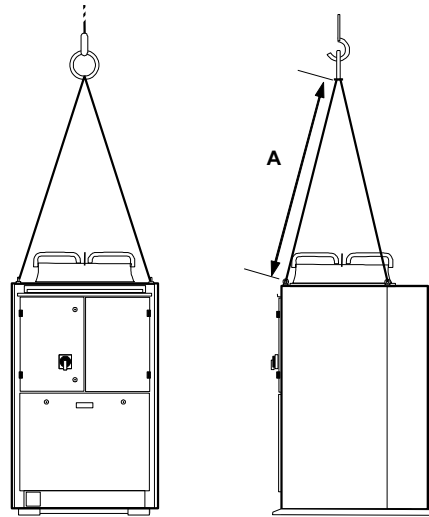

A = Minimum lifting chain length of 1500mm

Installation Data

POSITIONING

The installation position should be selected with the following points in mind:

- Position on a stable and even base, levelled to ensure that the compressor operates correctly
- Levelling should be to +/- 5mm
- Where vibration transmission to the building structure is possible, fit pad anti-vibration mounts and flexible water connections
- Observe airflow and maintenance clearances
- Pipework and electrical connections are readily accessible
- Where multiple units are installed, due care should be taken to avoid the discharge air from each unit adversely affecting other units in the vicinity
- Within a side enclosed installation, the fan MUST be higher than the enclosing structure
- Multiply x 2 airflow clearance for 3 side enclosed applications
- Ensure there are no obstructions directly above the fans
- Allow free space above the fans to prevent air recirculation

CAUTION  Prior to connecting services, ensure that the equipment is installed and completely level.

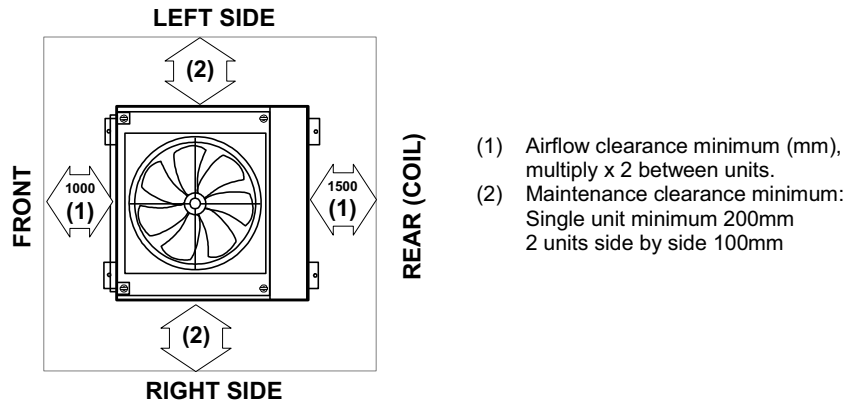

Installation Data

WATER SYSTEM

- Chilled water pipework and ancillary components must be installed in accordance with:
- National and Local Water supply company standards
 - The manufacturer's instructions are followed when fitting ancillary components
 - The system liquid is treated to prevent corrosion and algae forming
 - Glycol required as standard, with the correct concentration to suit the lowest ambient the equipment will experience
 - The schematic is referred to as a guide to ancillary recommendations

CAUTION  **The unit water connections are NOT designed to support external pipework, pipework MUST be supported separately.**

		LCC20	LCC40
Connections			
Water Inlet / Outlet - Type		PN16	PN16
Water Inlet / Outlet - Size	in	1 1/4	1 1/2
Water Drain/Bleed	in	1/2	1/2
Water System			
Min. System Water Volume	(2) l	112.0	207.4
Max. System Press	bar	10	10
OPTIONAL EXTRAS			
Water Pump	(1)	In Line Pump	
Max. System Press	bar	7	7
Nom. External Head:			
Single / Run & Standby - Standard	bar	85	87
Single / Run & Standby - Larger	bar	169	162
Expansion tank			
Water Capacity	l	8	12

(1) Based on 12/7°C water temperature and 35°C ambient with a 20% Ethylene Glycol Water Concentration.

(2) For minimum system volume calculation method, refer to the **Technical Manual**.

Pressure Testing

When all the pipework has been connected in the system, proceed as follows:

- Ensure all shut off and control valves are fully open
- Pressurise system to the operating pressure, hold for 1 hour (a gradual fall in pressure shown on the gauge indicates a leak)
- Leaks should be found and repaired and the unit pressure tested for a further hour

When the pressure remains at the operating pressure for 1 hour, the system can be considered leak free.

CAUTION  **Although a pressure of 1.5 x working pressure is adequate for testing purposes, most local water authorities require 2 x working pressure.**

RECORD  **Record on commissioning sheet provided once completed.**

Filling

CAUTION  **The whole system MUST be flushed prior to filling to remove debris left in the water pipework by using a flushing bypass as shown to avoid serious damage to the plate evaporator.**

All free-cooling units should use a MINIMUM 20% glycol concentration.

With auto-pressurisation system, regularly monitor the glycol concentration to ensure it does not fall below the minimum 20%.

During filling the system should be vented at all high points.

Once the system has been completely vented all vents should be closed.

To prevent air locking in the system it is advisable to fill the systems from the lowest point, ie drain point on pipework.

Installation Data

GLYCOL DATA

For a given percentage of glycol in the system there are correction factors that need to be applied, the following tables can be used as a guide.

CAUTION  All free-cooling units should use a **MINIMUM 20% glycol concentration**.

Ethylene Glycol Nominal Correction Factors

Glycol in System / Freezing Point °C		20% / -9°C	30% / -15°C	40% / -23°C
Output (kW)	x	1.00	0.98	0.96
Input (kW)		1.00	0.98	0.97
Water Flow (l/s)		1.00	1.09	1.12
Pressure Drop (kPa)		1.00	1.29	1.48

Propylene Glycol Nominal Correction Factors

Glycol in System / Freezing Point °C		20% / -6°C	30% / -12°C	40% / -20°C
Output (kW)	x	0.98	0.94	0.91
Input (kW)		1.00	0.98	0.97
Water Flow (l/s)		1.00	0.99	0.99
Pressure Drop (kPa)		1.08	1.22	1.35

Example

Model Ref. = **LCC40**
 Ambient: = 35°C
 Fluid = 30% Ethylene Glycol
 Inlet Fluid Temp. = 7°C
 Outlet Fluid Temp. = 12°C (5°C ΔT)

			Catalogue	Multiplier	Corrected Figure
Output (kW)	=	$\left\{ \frac{\text{Output}}{3.9 \times \Delta T} \right\}$	33.7	x 0.98	= 33.0 kW
Compressor Input (kW)			14.4	x 0.98	= 14.1 kW
Water Flow (l/s)			1.99	x 1.02	= 2.03 l/s
Pressure Drop (kPa)			Plot from curve (refer to Waterside Pressure Drops)	128	x 1.15

Where:
 Output = (kW) Output kW, refer to **Technical Manual**.
 Input = (kW) Input kW, refer to **Technical Manual**.
 ΔT = (°C) Difference of Entering Water and Leaving Water temperature

Installation Data

STANDARD RECOMMENDED INSTALLATION (Parts Supplied by Others)

General

Airedale offers a wide range of optional extras to suit various applications including integral pump, please refer to **Optional Extras - General** for details.

CAUTION ⚠ **Should non Airedale parts be used, the following installation recommendations should be adhered to. Failure to do this will invalidate the chiller warranty.**

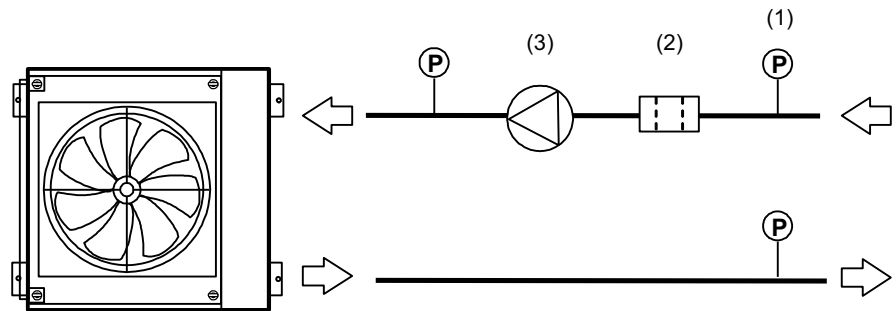

- (1) Pressure Sensors
- (2) Filter 1 1/16 BSP
- (3) Pump

CAUTION ⚠ **Full design water flow MUST be maintained at all times. Variable water volume is NOT recommended and will invalidate warranty**

CAUTION ⚠ **The correct operation of the flow proving device is critical if the chiller warranty is to be valid.**

CAUTION ⚠ **Following components are fitted within the chiller unit as standard:**

- Temperature Sensors
- Drain Point
- Auto Air Vent
- Differential Pressure Monitoring of Evaporator
- Pressure Sensing Points
- 20 Mesh Inlet Filter

Component Recommended Requirements

The recommended requirements to allow commissioning to be carried out correctly are:

- The inclusion of Binder Points adjacent to the flow and return connections, to allow temperature and pressure readings
- A water-flow commissioning valve set fitted to the system
- In multiple chiller installations, 1 commissioning valve set is required per chiller
- Isolating valves should be installed adjacent to all major items of equipment for ease of maintenance
- Balancing valves can be installed if required to aid correct system balancing
- All chilled water pipework must be insulated and vapour sealed to avoid condensation
- If several units are installed in parallel adjacent to each other, reverse return should be applied to avoid unnecessary balancing valves

Installation Data

PUMPS

Pump Statement

When installing circulating water pumps or equipment containing them, the following rules should be applied:

- Ensure the system is filled with liquid then vented and the pump primed with water before running the pump, this is required because the pumped liquid cools the pump bearings and mechanical seal faces
- To avoid cavitation the NPSH (Net Positive Suction Head) incorporating a safety margin of 0.5m head must be available at the pump inlet during operation

SYSTEM SCHEMATIC

Pump Packages (Optional Extras)

Flow Schemes:

- A** Standard Unit - No Pump
- B** Single Head Pump
- C** Run/Standby Pump

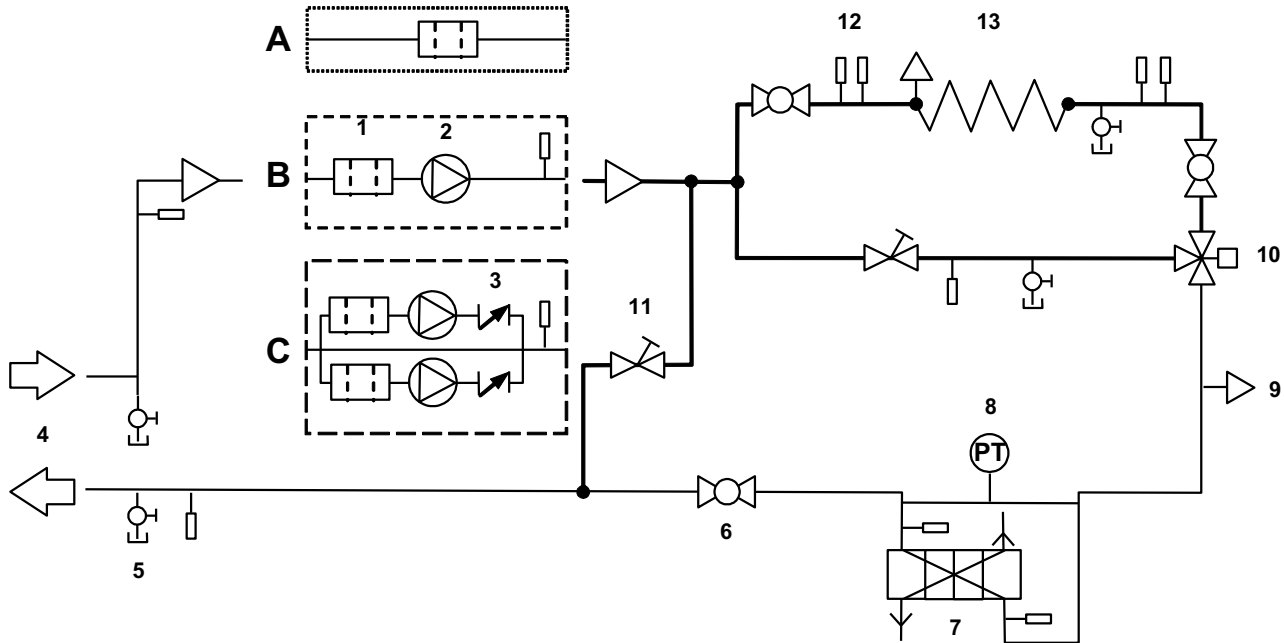

- | | | | |
|---|-----------------------|----|----------------------------------|
| 1 | Filter Ball Valve | 8 | Differential Pressure Transducer |
| 2 | Pump | 9 | Auto Air Vent |
| 3 | Non Return Valve | 10 | Mixing Valve |
| 4 | Water Supply & Return | 11 | DRV (Flushing Bypass) |
| 5 | Drain | 12 | Binder Points |
| 6 | Ball Valve | 13 | Free Cooling Coil |
| 7 | Condenser Coil | | |

Installation Data

ELECTRICAL

CAUTION  ALL work **MUST** be carried out by technically trained competent personnel.

 The equipment contains live electrical and moving parts, **ISOLATE** prior to maintenance or repair work.

General

- As standard the equipment is designed for 400V, 3 phase, 3 wire 50Hz and a separate permanent 230V, 1 phase, 50Hz supply, to all relevant IEE regulations, British standards and IEC requirements
- The control voltage to the interlocks is 24V, always size the low voltage interlock and protection cabling for a maximum voltage drop of 2V
- Avoid large voltage drops on cable runs, particularly low voltage wiring

CAUTION  A fused and isolated electrical supply of the appropriate phase, frequency and voltage should be installed.

Wires should be capable of carrying the maximum load current under non-fault conditions at the stipulated voltage.

A separately fused, locally isolated, permanent single phase and neutral supply **MUST BE FITTED** for the compressor oil heater (if fitted), evaporator trace heating and control circuits, **FAILURE to do so could INVALIDATE WARRANTY.**

Interlocks & Protection

Always electrically interlock the operation of the chiller with the pump controls for safety reasons.

CAUTION  Do not rely solely on the BMS to protect the chiller against low flow conditions.

If a pump package is not selected as part of the unit, an evaporator pump interlock **MUST** be directly wired to the chiller, to **Interconnecting Wiring** diagram. Failure to comply will invalidate the chiller warranty.

INTERCONNECTING WIRING

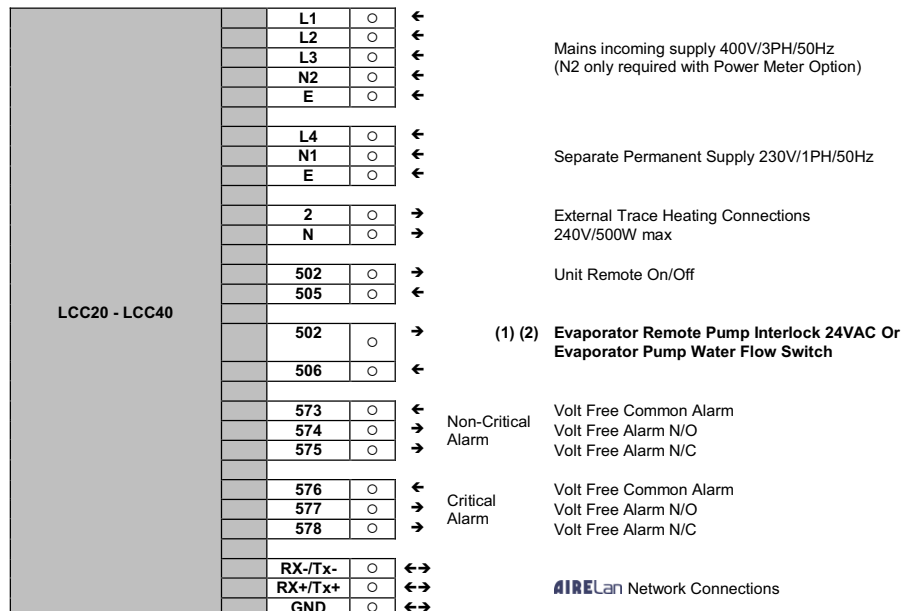

CAUTION  (1) **MUST** be directly wired to the chiller to validate warranty.
(2) Not required with integral pump package fitted.

Installation Data

ELECTRICAL DATA

IMPORTANT  The following information is for general guidance; the certified drawings provided must be referred to for installation.

			LCC20	LCC40
Unit Data				
Nominal Run Amps	(1)	A	14	28
Maximum Start Amps	(2)	A	103	117
Permanent Supply		VAC	230 V 1 PH 50 Hz	
Mains Supply		VAC	400 V 3 PH 50 Hz	
Rec Permanent Fuse Size		A	16	16
Rec Mains Fuse Size		A	25	40
Max Permanent Incoming Cable Size		mm ²	4 mm ² terminals	
Max Mains Incoming Cable Size		mm ²	35 (Direct to Isolator)	
Control Circuit		VAC	24V/230VAC	
Evaporator				
Pad Heater Rating		W	25	25
External Trace Heating				
Available (fitted by others)		W	500	500
AC Condenser Fan - Per Fan				
Quantity			1	1
Motor Size		kW	0.98	1.80
Full Load Amps		A	1.75	3.80
Locked Rotor Amps		A	6.20	11.00
Compressor - Per Compressor				
Quantity			1	1 + 1
Motor Size		kW	6.8	6.8 / 6.4
Nominal Run Amps	(1)	A	12.1	12.1 / 11.7
Start Amps	(2)	A	101	101 / 101
Type Of Start			Direct on line	
OPTIONAL EXTRAS				
Compressor Oil Heater Rating		W	70	70 / 70
Electronic Soft-start				
Nominal Run Amps	(1)	A	14	28
Maximum Start Amps		A	63	77
Recommended Mains Fuse		A	25	40
EC Condenser Fan - Per Fan				
Quantity			1	1
Full Load Amps		A	3.20	4.80
Motor Size		kW	1.95	3.1
Water Pump				
Single Head or Run/Standby - Standard				
Unit Nominal Run Amps	(1)	A	15	30
Recommended Mains Fuse		A	25	40
Motor Size		kW	0.37	0.50
Full Load Amps		A	1.40	1.90
Single Head or Run/Standby - Larger				
Unit Nominal Run Amps	(1)	A	16	31
Recommended Mains Fuse		A	25	40
Motor Size		kW	0.75	0.90
Full Load Amps		A	2.30	3.00

(1) To ARI standard conditions ARI 540 (7.2°C evaporating; 54.4°C condensing).

(2) Starting amps refers to the direct on line connections.

AIRETronix Controls

GENERAL DESCRIPTION The **AIRETronix** microprocessor controller offers powerful analogue and digital control to meet a wide range of monitoring and control features including a real time clock and Industry standard communication port and network connections.

The controller's inbuilt display is used for viewing the unit operating status and making adjustments to control parameters by allowing the operator access to a series of display pages.

Also featured are a visual alarm and the facility to adjust and display control settings by local operator for information and control.

TEMPERATURE CONTROL

The unit has been designed to provide the cooling load required whilst optimising energy efficiency **at all times** and as such will take advantage of **free cooling** whenever available. If the free cooling available cannot satisfy the required full cooling load, DX mechanical cooling is used to supplement the output.

Airedale recognises that all chiller applications are different but fall mainly into 2 application categories; Variable Supply Temperature and Constant Supply Temperature.

The onboard microprocessor has the capability of satisfying either control requirement using the Airedale Variable Supply Temperature control scheme; energy savings are available when compared with previous schemes and that of the Constant Supply Temperature application.

Variable Supply Temperature control schemes offer energy savings where the supply water temperature is not critical to its operation. By monitoring the temperatures of the return and supply water the units cooling capacity is adjusted through use of the microprocessor controls to maintain an average temperature set point between the supply and return temperatures.

Selection of the best application control scheme can be made via a soft switch in the microprocessor during initial commissioning.

CAUTION  **Factory set to Variable Supply Temperature Control unless otherwise stated at order.**

Only when the mode selection has been set can the unit be enabled.

AIRETronix Controls

OPERATION

Display/keypad

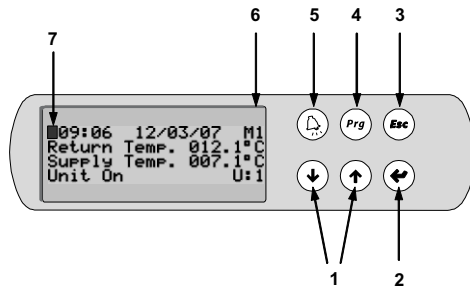

- 1 UP/DOWN KEYS - To change Adjustable Fields & Scrolls up & down available Menus
- 2 ENTER -Selects Menus & Moves Cursor to Adjustable Fields Green LED
- 3 ESC - Green LED lit when Operating Page displayed, Returns to Operating Page Screen when pressed
- 4 PROGRAM - Opens the Available Menus
- 5 ALARM - Red LED Indicates Alarm Present
- 6 4 ROW LCD DISPLAY
- 7 CURSOR (FLASHING) Top Left Position = "HOME" Indicates adjustable Fields

Navigation

The display is used for **Viewing Unit Operating Status** and **Adjusting Customer Control Settings** by allowing the operator access to a series of **Menus & sub-menus**. Viewing information is unrestricted, however set up and adjustment requires password entry, refer to **Password Protection**.

Initially, use the **Prq** key to **access Menus**, the symbol ← will appear top right and the first menu will appear in CAPITALS, these **indicators** shows which menu is selected.

Use the **↓** **↑** keys to **move the indicator ←** to the desired menu and press **↵** to **open** the menu.

Use the **↵** key to **move the flashing cursor** to adjustable **fields** and the **↓** **↑** keys to change the values.

Press the **↵** key to **move the cursor** to the next **field** or **Home**.

When the cursor is **Home** either use the **↓** **↑** keys to scroll to next **sub-menu** or the **Esc** to **exit** and **return** to the **Standard Operating** page.

AIRETronix Controls

OPERATION

Standard Operating Page

The **Operating Page** will appear and remain present following start up of the controller as illustrated:

```
Free Cool           M1
Inlet Temp.        06.0°C
Ambient Temp.      01.0°C
FreeC Valve        000.0%
```



```
13:12 27/10/05 M0
Return Temp.       07.0°C
Supply Temp.       06.0°C
OFF by Keyboard Mst
```

The following **Menus** can be accessed from the **Operating Page**, it is recommended that the display is always returned to the **Operating Page** by using the  key

Password Protection

To guard against unauthorised adjustments, a password is required to gain access to certain menus as defined below.

FACTORY SET PASSWORD PIN NUMBER: 4648 (or Customer chosen number).



When a password is requested use the   keys to enter the number and  to access the page.

Menus (Listed in Sequence)

Menu	Description	Password
Switch On/Off	Enable or Disable the unit	Open Access
Service	Allows selection of setpoint limits, enables unit on/off from display, remote on/off and remote pump on/off.	Default 4648
Setpoint	Allows setpoint adjustment, includes supply temperature setpoint and unit temperature differential.	Default 4648
Status	Displays current status on digital and analogue inputs and outputs.	Open Access
Maintenance	Displays hours run for compressors and pumps (if fitted). Also includes Electronic Expansion Valves (if fitted).	Default 4648
Clock	Allows adjustment of real time clock, time zones	Default 4648
Alarm Log	Display last 100 alarms in chronological order.	Open Access
Manufacturer	Factory use only.	Airedale Only

SETTING UP

Unit ON/OFF

By pressing the  and  simultaneously for approximately 5 seconds, the unit operation will stop or start. The unit can also be enabled through the Switch On/Off menu.

Real Time Clock

The units leave the factory set, however follow the **Navigation** instructions if necessary.

Time Zones

The programme provides 3 On/Off periods per day, 7 days per week. The unit is factory set for continuous operation.

Technical Support

For further details, please contact Airedale.

AIRETronix Controls

VIEWING UNIT OPERATING STATUS

Status Menu

Allows access to view operating status of Digital and Analogue Inputs and Outputs.

Using the **Navigation** instructions, the following **Sub-Menus** shown in sequence can be accessed:

20kW Unit		40kW Unit	
Digital Inputs			
ID1	Phase Rotation or MCCB Status	Phase Rotation or MCCB Status	
ID2	Emergency Stop	Emergency Stop	
ID3	Not Used	Not Used	
ID4	Remote On/Off	Remote On/Off	
ID5	Compressor 1 Contactor Status	Compressor 1 Contactor Status	
ID6	Not Used	Compressor 2 Contactor Status	
ID7	Digital Compressor Module Alarm	Digital Compressor Module Alarm	
ID8	Not Used	Not Used	
ID9	Low Pressure Switch	Low Pressure Switch	
ID10	Not Used	Not Used	
ID11	Pump 1 Contactor Status (Optional)	Pump 1 Contactor Status (Optional)	
ID12	Pump 2 Contactor Status (Optional)	Pump 2 Contactor Status (Optional)	
ID13	Remote Pump On/Off	Remote Pump On/Off	
ID14	Remote Summer/Winter Or Night Setback	Remote Summer/Winter Or Night Setback	
ID15	Not Used	Not Used	
ID16	Not Used	Not Used	
ID17	Not Used	Not Used	
ID18	Not Used	Not Used	
Digital Outputs			
NO1	Compressor 1 Contactor	Compressor 1 Contactor	
NO2	Not Used	Compressor 2 Contactor	
NO3	Pump 1 Contactor (Optional)	Pump 1 Contactor (Optional)	
NO4	Not Used	Not Used	
NO5	Not Used	Not Used	
NO6	Pump 2 Contactor (Optional)	Pump 2 Contactor (Optional)	
NO7	Condenser Coil Valve 1	Condenser Coil Valve 1	
NO8	Condenser Coil Valve 2	Condenser Coil Valve 2	
NO9	Condenser Coil Valve 3	Condenser Coil Valve 3	
NO10	Not Used	Not Used	
NO11	Not Used	Not Used	
NO12	Non Critical Alarm	Non Critical Alarm	
NO13	Critical Alarm	Critical Alarm	
NO14	Evaporator Heater Pad	Evaporator Heater Pad	
NO15	Not Used	Not Used	
NO16	Not Used	Not Used	
NO17	Not Used	Not Used	
NO18	Not Used	Not Used	
Analogue Inputs			
B1	Liquid Pressure	Liquid Pressure	
B2	Leak Detector (Optional)	Leak Detector (Optional)	
B3	Suction Pressure	Suction Pressure	
B4	Return Water Temperature	Return Water Temperature	
B5	Supply Water Temperature	Supply Water Temperature	
B6	Not Used	Not Used	
B7	Chilled Water Differential Pressure	Chilled Water Differential Pressure	
B8	Remote Setpoint Adjustment	Remote Setpoint Adjustment	
B9	Evaporator Inlet Water temperature	Evaporator Inlet Water temperature	
B10	Ambient Temperature	Ambient Temperature	
Analogue Outputs			
Y1	Free Cooling Valve	Free Cooling Valve	
Y2	Condenser Fan Speed	Condenser Fan Speed	
Y3	Digital Compressor	Digital Compressor	
Y4-Y6	Not Used	Not Used	

AIRETronix Controls

COMMON ALARMS	Outlined below is a selection of Common Alarms, a full list is available, please contact Airedale.
Phase Rotation or MCCB	A normally closed contact. When Phase Rotation is incorrect all controller outputs are de-activated.
Emergency Stop	A normally open contact. On closing, all controller outputs are de-activated.
Evaporator Flow Failure	A normally closed contact. On opening, all controller outputs are de-activated.
Low Supply Temperature	Supply Water Temperature Low Limit alarm is generated when the supply water temperature falls below the low limit value set. All controller outputs are de-activated.
INDIVIDUAL CIRCUIT ALARMS	Outlined below is a selection of Individual Circuit Alarms, a full list is, please contact Airedale.
Electronic Expansion Valve Failure	This indicates that the electronic expansion valve controller has detected an operating problem.
Low Suction Pressure	When the suction pressure sensor value falls below the value set by the low suction level for a period exceeding 1 minute (or 3 minutes on compressor start-up), a visual alarm will be generated at the in-built display and the relevant compressor will be de-activated. On units with tandem compressors, both compressors from the same circuit will be switched off.
High Liquid Pressure	When the liquid pressure reaches 25 Barg, the relevant circuit will be switched off and an alarm activated, this can only be rectified by manual reset via the microprocessor.
Compressor Status	A normally closed contact when the compressor is operating. If this contact remains open for a period of 3 seconds during operation of the compressor, a visual alarm is generated and the relevant compressor will be de-activated. This alarm comprises of compressor motor protection module, discharge gas thermostat and safety high pressure switch.

Commissioning Data

OPERATING LIMITS

(20% Ethylene Glycol Concentration)

Standard Unit	
Minimum Ambient Air DB °C	-20°C
Maximum Ambient Air DB °C	Refer to Technical Manual - Performance Data
Minimum Leaving Water Temperature °C	+5°C
Maximum Return Water Temperature °C	+20°C
Minimum / Maximum ΔT	4°C / 8°C

1 For conditions outside those quoted, please refer to Airedale.

MECHANICAL DATA

	LCC20		LCC40	
	Single		Tandem	
Compressor				
Type	Digital Scroll		1 Digital + 1 Standard Scroll	
Quantity	1		2	
Oil Charge Volume (Total)	1.69		1.69	
Oil Type	Polyol Ester			
Refrigeration	Dual Circuit			
Refrigerant Control	Electronic Expansion Valve (EEV)			
Refrigerant Type - Precharged	R410A			
Charge (Total)	6.8		10.3	

Commissioning Data

WATERSIDE PRESSURE DROPS

(20% Ethylene Glycol Concentration)

CAUTION  Full design water flow **MUST** be maintained at all times. Variable water volume is **NOT** recommended and will invalidate warranty

Unit Pressure Drop

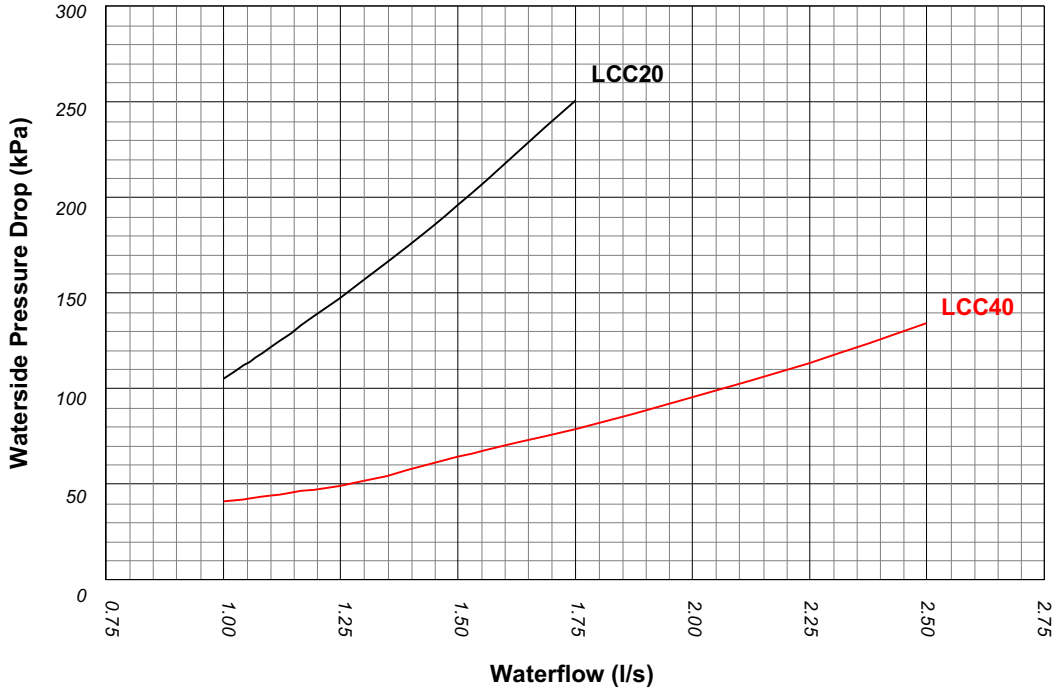

- (1) For glycol solutions, please refer to **Glycol Data**.
- (2) Chiller pressure drop refers to standard unit.

Unit Evaporator Pressure Drop



Commissioning Data

PUMP PACKAGES (OPTIONAL EXTRAS)

Use the formula below and the graphs provided to calculate the External Head Available:

Example:

Model Ref. = **LCC40**
 Ambient: = 35°C
 Fluid = 20% Ethylene Glycol
 Inlet Fluid = 7°C
 Outlet Fluid = 12°C (**5°C ΔT**)
 Pump Selection = Single Standard
 Water Flow l/s = 1.87 l/s

$$\begin{aligned}
 \text{EHA (kPa)} &= \text{External Head Available} \\
 \text{EHA (kPa)} &= \left\{ \begin{array}{c} \text{Total Pump Head Available} \\ - \\ \text{Unit Waterside Pressure Drop} \end{array} \right\} \\
 \text{EHA (kPa)} &= \left\{ \begin{array}{c} 165 - 82 \end{array} \right\} \\
 \text{EHA (kPa)} &= \underline{\underline{83 \text{ kPa}}}
 \end{aligned}$$

Commissioning Data

PUMP PACKAGES (OPTIONAL EXTRAS)

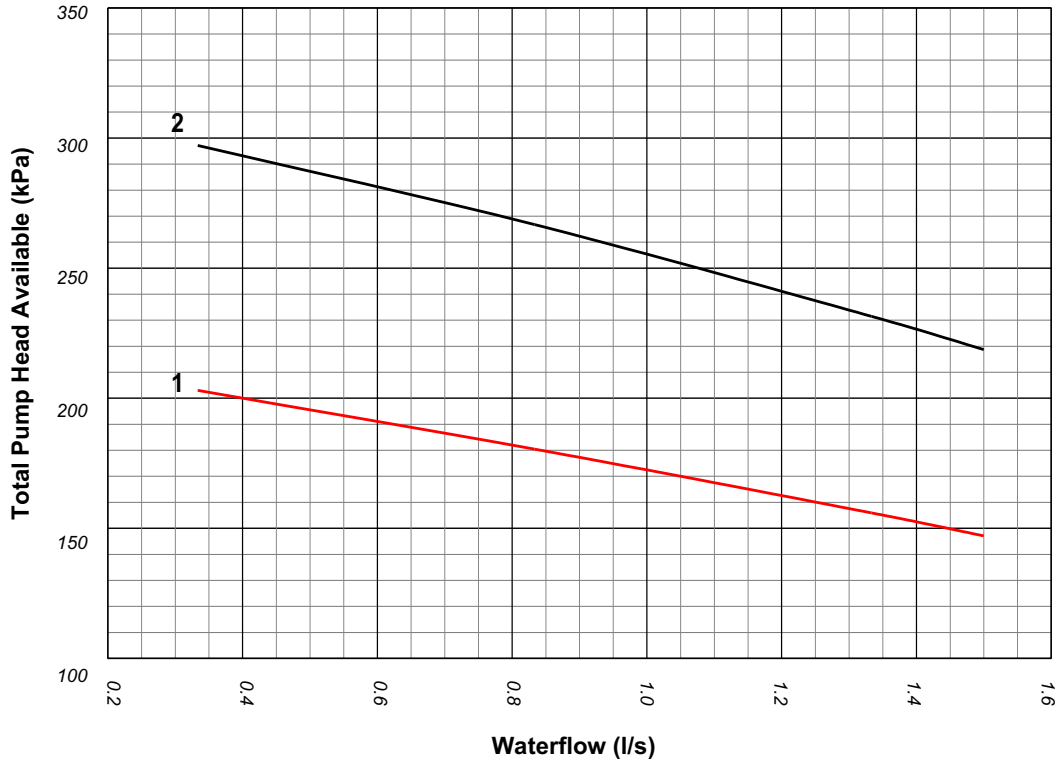

		Single Head Pump or Run / Standby Pump	
		Standard	Larger
LCC20	Curve	1	2
LCC40	Curve	3	4

Commissioning Data

OPERATIONAL SEQUENCE

Refrigerant Charge Check for the presence of a refrigerant charge in the condenser side.

Compressor Oil Heater The mains supply to the compressor oil heater should be switched on at least 12 hours prior to compressor starting to avoid refrigerant migration.

CAUTION  **A separately fused, locally isolated, permanent single phase and neutral supply MUST BE FITTED for the compressor oil heater (if fitted), evaporator trace heating and control circuits, FAILURE to do so could INVALIDATE WARRANTY.**

Pre-Start-Up Check Before compressor start-up, make sure that an oil level is showing in the compressor sight glass, and that all refrigerant ball valves are opened.

CAUTION  **Check phase rotation by connecting pressure gauges to the suction and discharge ports, if no differential pressure occurs, isolate immediately.**

Adding Refrigerant The unit is supplied with a full refrigerant charge, additional refrigerant should be added to the system via 1/4" Schrader connection on the expansion line if required.

Pump Down Never pump down without the low pressure trip and high discharge temperature switches being operative.

UNLOADING PROTECTION

Head Pressure The microprocessor has inbuilt protection against nuisance trips. If the head pressure rises above 35Barg the system will unload 1 compressor and remain unloaded until the head pressure drops below 33Barg.

Low Pressure If low pressure drops below the microprocessor setting, the compressor will unload to 1 compressor, if low pressure persists for 1 minute, the circuit will be switched off and sound an alarm.

Commissioning Procedure

GENERAL

To be read in conjunction with the commissioning sheets provided, items highlighted should be recorded.

CAUTION  **Please ensure all documents have been completed correctly and return to Technical Support immediately to validate warranty.**

PRE COMMISSIONING CHECKLIST

CAUTION  **ALL work MUST be carried out by technically trained competent personnel.**

 **The equipment contains live electrical and moving parts, ISOLATE prior to maintenance or repair work.**

The door interlocking mains isolator should be in the OFF position.

Ensure all items listed in the pre commissioning section are complete.

RECORD  The unit should be visually inspected and any damage noted.

- Secure commissioning gauges to the high side of the system, check for a positive charge
- Check tightness of electrical components and properly terminated
- Check that the remote on/off switch (if fitted) is in the off position
- With the MCBs in the off position measure the incoming voltage
- Check Phase Rotation
- Check voltage at permanent supply
- Measure and record the primary (230V) and secondary (24V) voltages at each of the transformers, adjust tapping if necessary and record on the commissioning document
- Check all timer settings are correct
- Check compressor oil heater (if fitted) (ensure this is switched on for a minimum of 12 hours prior to the unit operation)
- Check oil level of each compressor
- Check water filter is fitted
- Check design water flow is available
- Check flow proving device and pump interlocks are fitted to the water system and wired directly to the chiller
- Switch on the controls and individual circuits, primary and secondary, MCBs to the ON position, at this stage the control display panel should be illuminated
- Record Optional Extras
- Record Controller Data

CAUTION  **Disable remote ON/OFF to ensure the unit does not start unintentionally.**

The chiller will not start until microprocessor control SWITCH 1 is in the ON position. DO NOT SWITCH TO ON AT THIS STAGE

- Adjust the water temperature supply and return set points (if necessary) to call for 100% cooling (refer to the **Controls** section)
- Ensure all KNOBS and SWITCHES are adjusted to suit the design requirements (refer to the **Controls** section)

To switch the unit ON, use the microprocessor keypad as follows:

Press  , press  , press  , press  & finally  .

CAUTION  **There will always be a delay between the enabling of the unit and the energising of the compressor contactors, anything between 1 to 2 minutes. Be patient.**

Commissioning Procedure

PRE COMMISSIONING CHECKLIST

- Check that each circuit trips on low pressure, the alarm should appear within 3 minutes
- The alarm will be recognised at the display circuit trip, to clear the alarms refer to **Alarm Handling**

CAUTION  **Prior to the chiller compressors being allowed to start, the Water Flow Fail and Pump Interlock features MUST both be proven to work correctly.**

- To check the water flow fail safety protection is working satisfactorily:

RECORD 

Reduce the flow rate to 75% of design and ensure that the evaporator pressure or flow protection device initiates a trip at this flow rate, adjust as necessary.





With compressors off, ensure this alarm is recognised as **Water Flow Fail** at the display and disengages the circuits operation immediately. Restore flow rate to the design and check the alarm has self-cleared.

- To check the pump interlock safety feature works satisfactorily:

RECORD 

Switch off the chiller water pump and check the interlock wiring connections at the chiller are open circuit.

To switch the unit OFF, use the microprocessor keypad as follows:

Press  , press  , press  , press  & finally .

Fully open all liquid line and discharge service ball valves on each circuit.

Commissioning Procedure

COMMISSIONING CHECKLIST

IMPORTANT  The digital scroll compressor is always operating at either 100% or 0% mass flow. When inspecting the refrigerant system with gauges, this is evident by pulsing of the system pressures. All pressure measurements **MUST** be taken when the digital scroll compressor is compressing refrigerant (solenoid de-energised).

The following should be carried out with a load on the system, otherwise the unit is likely to short cycle.

- Switch the door interlocking mains isolator to the ON position but again only on the circuit which is to be tested
- Adjust the water temperature supply and return set points to match the system requirements

To switch the unit ON, use the microprocessor keypad as follows:

Press , press , press , press  & finally .

- Check pressures at suction and discharge ports for correct phase rotation

CAUTION  If no differential pressure occurs, isolate immediately.

- RECORD** 
- Measure and record the compressor amps once the compressors are fully loaded
 - Measure and record full speed amps of each condenser fan(s)

CAUTION  The microprocessor LP setting is adjustable via the micro display. It is recommended that this setting be 0.4Bar below the equipment freezing point of the cooling medium ie:





with a 20% Ethylene Glycol water concentration LP micro settings is 1.9BarG.

- Ensure that the low water temperature safety cuts out at the correct setting +/- 0.5°C, to clear the alarms refer to **Alarm Handling** section

- RECORD** 
- Check the liquid line sight glass is clear and dry
 - Check the superheat is between 5 - 8°C at all operating loads
 - Check and record the following:
Suction and discharge pressures
Liquid, discharge and suction line temperature
Water inlet and outlet temperature

- Ensure the above are all within the design parameters
- Repeat as follows for each circuit:

To switch the unit OFF, use the microprocessor keypad as follows:

Press , press , press , press  & finally .

- To switch the unit ON, repeat above

The unit is now commissioned and will provide many years of trouble free operation providing the following maintenance schedule is followed.

Maintenance

CAUTION  ALL work **MUST** be carried out by technically trained competent personnel.

 The equipment contains live electrical and moving parts, **ISOLATE** prior to maintenance or repair work.

IMPORTANT  **UK MAINLAND** - The Chiller Maintenance Record and supporting maintenance documents **MUST** be complete and available on request to validate warranty.

The Chiller Maintenance Record is located within the unit control panel.

GENERAL MAINTENANCE

The maintenance schedule indicates the time period between maintenance operation.

3 MONTHS	ACTION	NOTES
REFRIGERATION	Check the following and compare results with commissioning records. <ul style="list-style-type: none"> Suction and discharge readings Head pressure control is maintained Pressure relief indicator gauge Check each circuit sight glass for dryness and bubbles for indication of leaks Check compressor oil level and shell/sump temperature Visually inspect the unit for oil patches 	Investigate and rectify variations. Remember to re-cap the Schrader connections! Investigate and repair possible leaks.
SYSTEM	Check the following against the commissioning records. <ul style="list-style-type: none"> Control settings Alarm log for unusual occurrences Chilled water control maintains design temperature Chilled water flow is within design limits of zero to plus 10% Concurrently ensure chilled water pump and flow proving device operate efficiently, and that interlocks function correctly Operation of flow proving device and pump interlock 	Investigate and adjust as necessary.
Finally!	Record operating conditions.	
FABRIC	Visually inspect the unit for general wear and tear, treat metalwork. Visually inspect pipe and pipework insulation. Clean evaporator water strainer. Clean condenser coils. Do not steam clean use detergent and stiff bristled brush. For heavy dirt, use either a high pressure water or chemical hose. Visually check the following: <ul style="list-style-type: none"> Pipework clamps are secure Tightness and condition of fan and compressor mounts Anti-Vibration mounts fixings (if fitted) 	Rust should be inhibited, primed and touched up with matching paint (available from Airedale or your Distributor). Repair/rectify as necessary. At first maintenance visit and then as frequently as necessary (12 months). Do not damage fins and comb out if necessary. Secure/tighten as necessary.
Finally!	Ensure control panel lids and access panels have been correctly replaced and securely fastened in position.	

Maintenance

GENERAL MAINTENANCE

6 MONTHS	ACTION	NOTES
	Repeat 3 month checks plus the following:	
SYSTEM	Check evaporator trace heating and low ambient thermostat are set to activate at 4.0°C.	Remember to re-cap the Schrader connections!
12 MONTHS	ACTION	NOTES
	Repeat 6 month checks plus the following:	
SYSTEM	Check safety devices cut out the compressor at the correct settings.	
REFRIGERATION	Check glycol concentration if appropriate.	Adjust as necessary.
	Leak test all refrigerant joints and inspect all water connections.	Rectify as necessary.
	Check superheats with chiller running on full load (the height of summer is recommended). Recheck the charge following major adjustment of the superheats.	Adjust as necessary. A period of 30 minutes should be allowed between each resetting of the valve to allow pressures to stabilise. Thermostatic expansion valve only.
ELECTRICAL	Tighten all electrical terminals.	

COMPRESSOR MAINTENANCE

Periodic maintenance and inspection of this equipment is necessary to prevent premature failure, the following periodic inspections should be carried out by period or hourly use which ever is sooner.

1 Year	Measure compressor motor insulation.
7,500 Hours or 4 Years	Inspect compressor oil.

SHUT DOWN PERIODS

For periods of winter shut down the following precautions are recommended:

- Close the liquid and discharge ball valve
- Cap service ports
- Turn off electrical circuits
- Drain the water from the chiller evaporator via the evaporator drain plug

Notes:

Parts Identification

SPARES

For ease of identification when ordering spares or contacting Airedale about your unit, please quote the unit type, unit serial number and the date of manufacture, which can be found on the unit serial plate.

A spares list for 1, 3 and 5 years will be supplied with every unit and is also available from our Spares department on request.

The serial plate can be located inside Item 1.

UK MAINLAND - Chiller Maintenance Record can be located inside Item Electrical Panel or **No 1**.

LCC20 Shown

- 1 Control Panel Access
- 2 Door Interlocking Mains Isolator
- 3 Incoming Customer Mains supply
- 4 **Mains / Control Panel**
- 5 **Compressor Compartment**
- 6 Fan Speed Controller (located to Mains Panel (4) in LCC40)
- 7 High Pressure Switch
- 8 Compressor
- 9 Low Pressure Switch
- 10 Electronic Expansion Valve (EEV)
- 11 Microprocessor Controller
- 12 Digital Compressor EEV Controller
- 13 Transformer
- 14 Mixing Valve
- 15 Manual Balancing Valve
- 16 Flushing Bypass
- 17 Suction Pressure Transducer
- 18 Liquid Line Sight Glass
- 19 Liquid Line Filter Drier
- 20 Auto Pressurisation Air Vent
- 21 Condenser Coil Guard
- 22 Water Supply - BSP Male Connection
- 23 Water Return - BSP Male Connection
- 24 Removable Lifting Eye Bolts
- 25 Unit Drain Point Access

Parts Identification

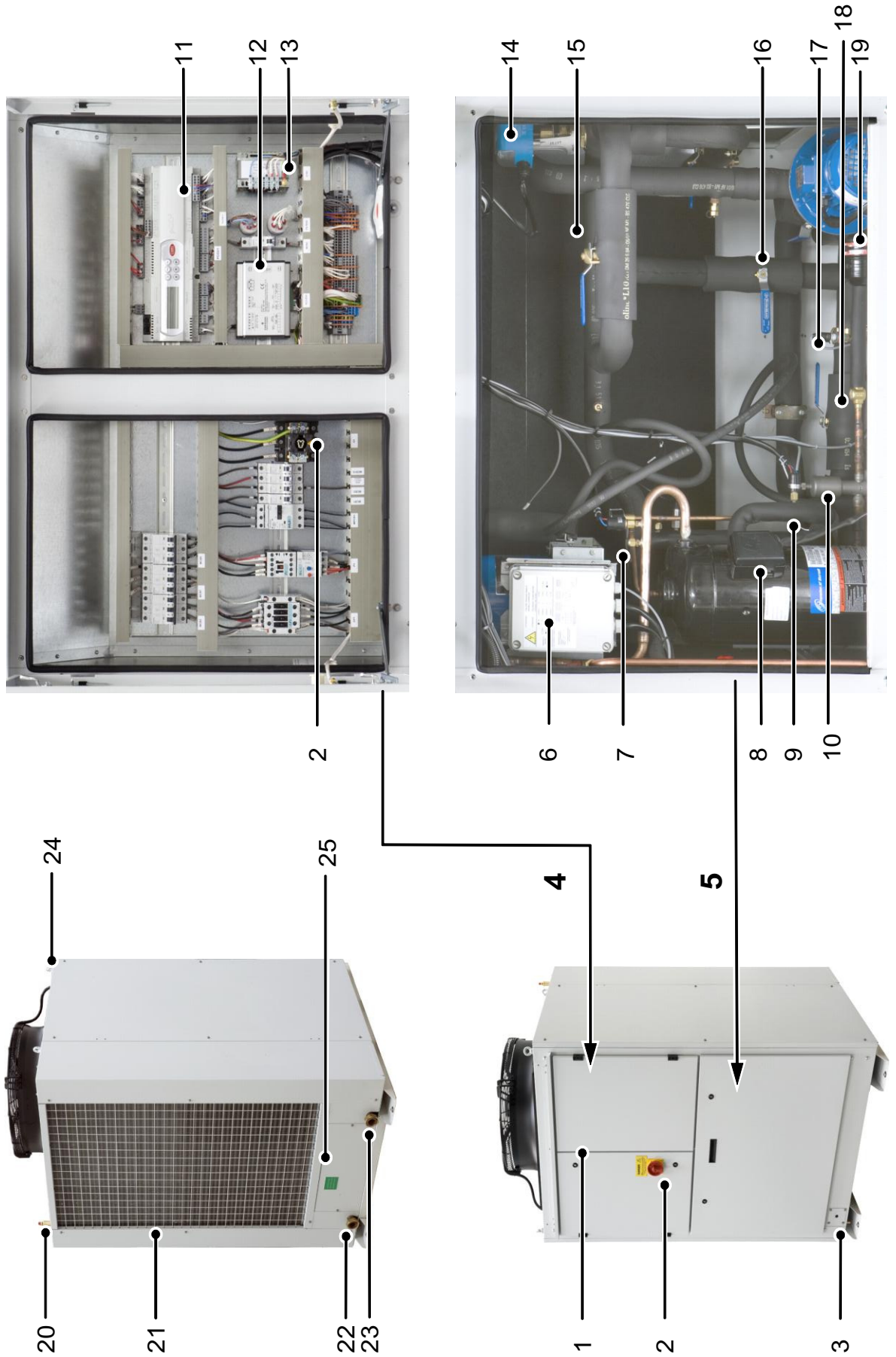



Head Office:

Airedale International Air Conditioning Ltd

Leeds Road
Rawdon
Leeds LS19 6JY
United Kingdom

Tel: +44 (0) 113 239 1000

Fax: +44 (0) 113 250 7219

e-mail: enquiries@airedale.com

website: www.airedale.com

A *MODINE* Company



SYSTEMY HVAC Sp. z o.o.
ul. Rydygiera 8, 01-793 Warszawa

tel.: +48 22 101 74 00

fax: +48 22 101 74 01

e-mail: biuro@systemy-hvac.pl

www.systemy-hvac.pl

PART NO:	ISSUE	DATE
6560544	A	01/06/2007
	B	04/2011
	C	09/2012
	V1.3.0	02/2013